

DOLI 160x200

Art.-Nr.

398 693
398 694
398 695
398 696

1636
787
2032
mm

1/6
VO
36-2024

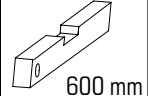
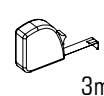
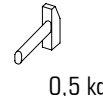
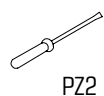
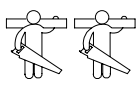

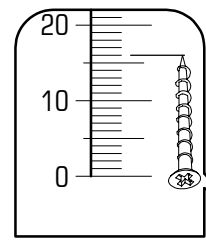
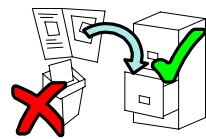
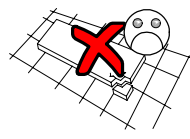
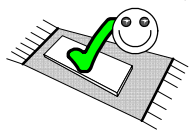
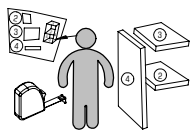
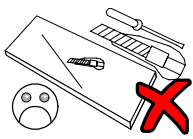
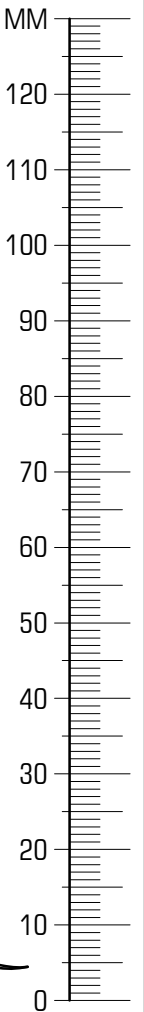
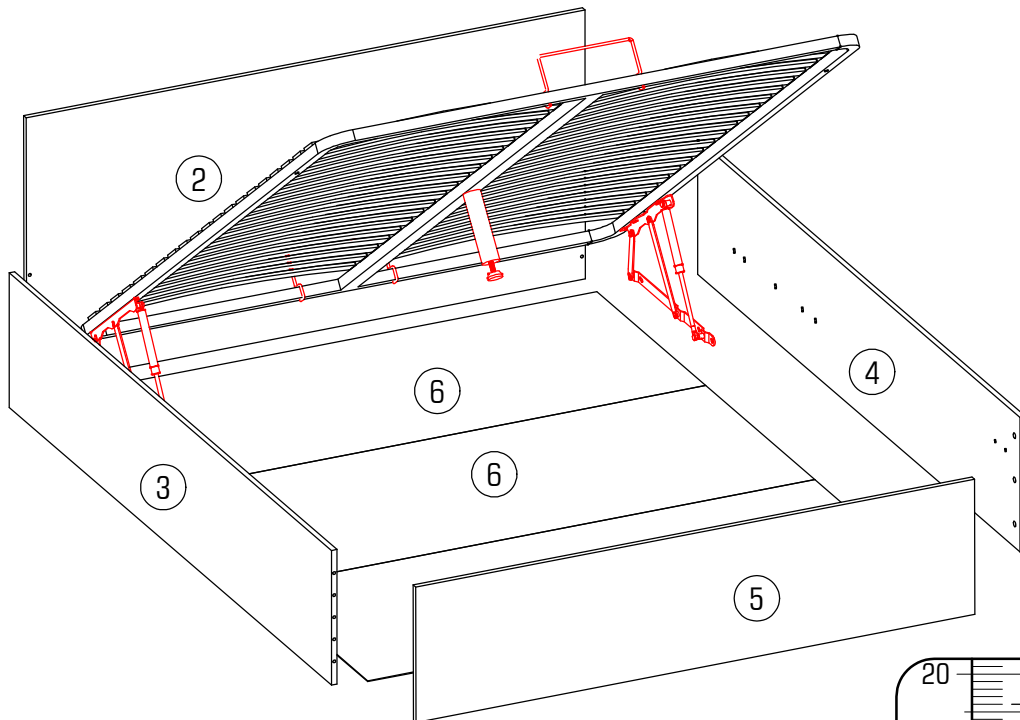
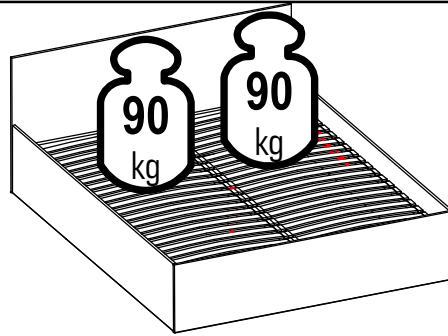

ID	ID	Image	Image	Image
21611	②	1636*780*16	1x	1/4
21587	③	2000*390*16	1x	2/4
21588	④	2000*390*16	1x	2/4
21612	⑤	1636*392*16	1x	2/4
21613	⑥	676*1628*3	3x	1/4
			1x	3/4
			1x	4/4

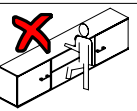
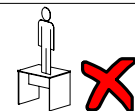
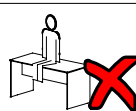
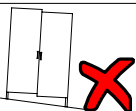
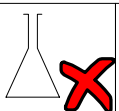

21102,00		Ø1,6x20	22205,02		Ø5,0x16	22510,00		M6,0x14	22300,00		Ø7x50	37148,00		1000 N	37147,00		37153,00		37153,00		
A	100x		B	8x		C	10x		D	6x		E	2x		F	2x	G	1x	H	1x	
22800,01		4	24091,00		Ø10x11	27000,00		Ø8x30	30091,00		10x	70013,01		Ø15x13	70021,01		6x	Q1	6x	Q2	6x
J	1x		K	10x		L	8x		M	10x		N	6x		P	6x	Q1	6x	Q2	6x	
37106,00		2x	37146,00		M6,0x40	37148,00		4x	37148,00		1x	37148,00		1x	37148,00		M6,0	37153,00		M8,0x40	1x
R	2x		T	4x		U	4x		V	1x		W	1x		X	4x	Y	1x			

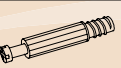

2/6 DOLI 160x200

			
Ø10x11	Ø8x30	Ø15x13	
K 10x	L 8x	N 6x	P 6x

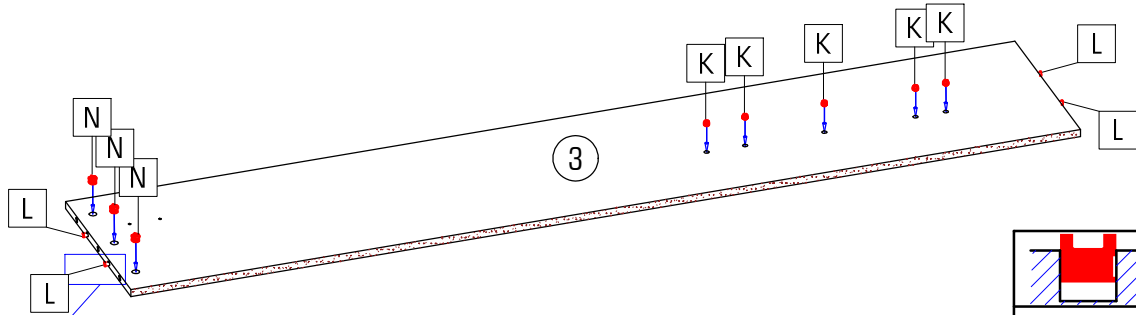
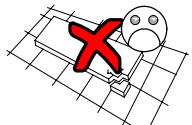
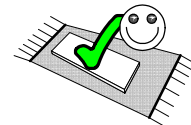

3

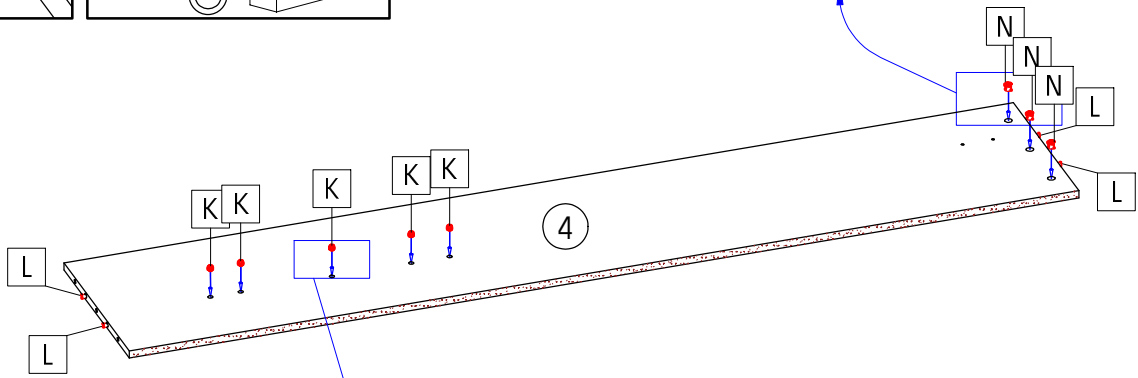
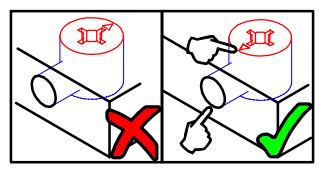
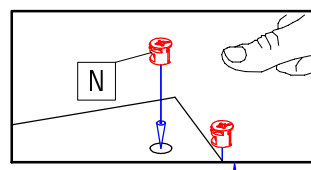
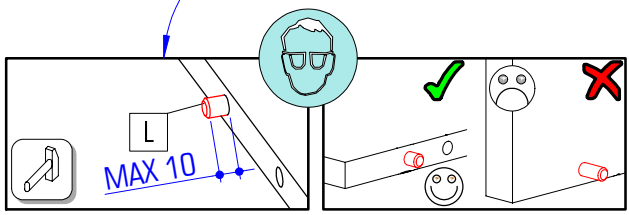
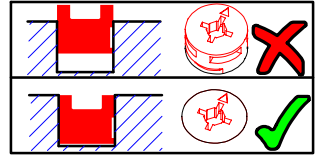

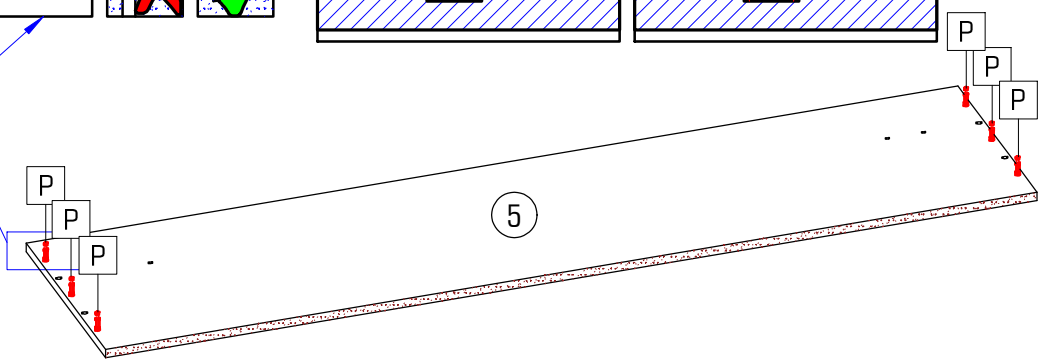
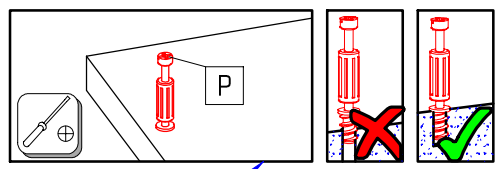
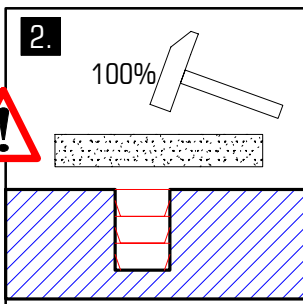
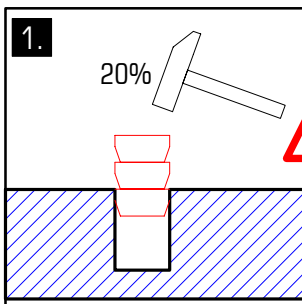
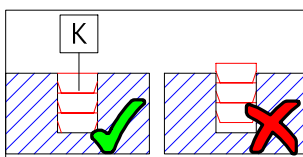
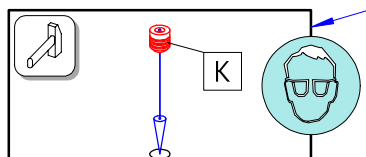

4



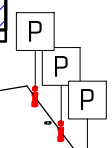

5

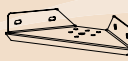

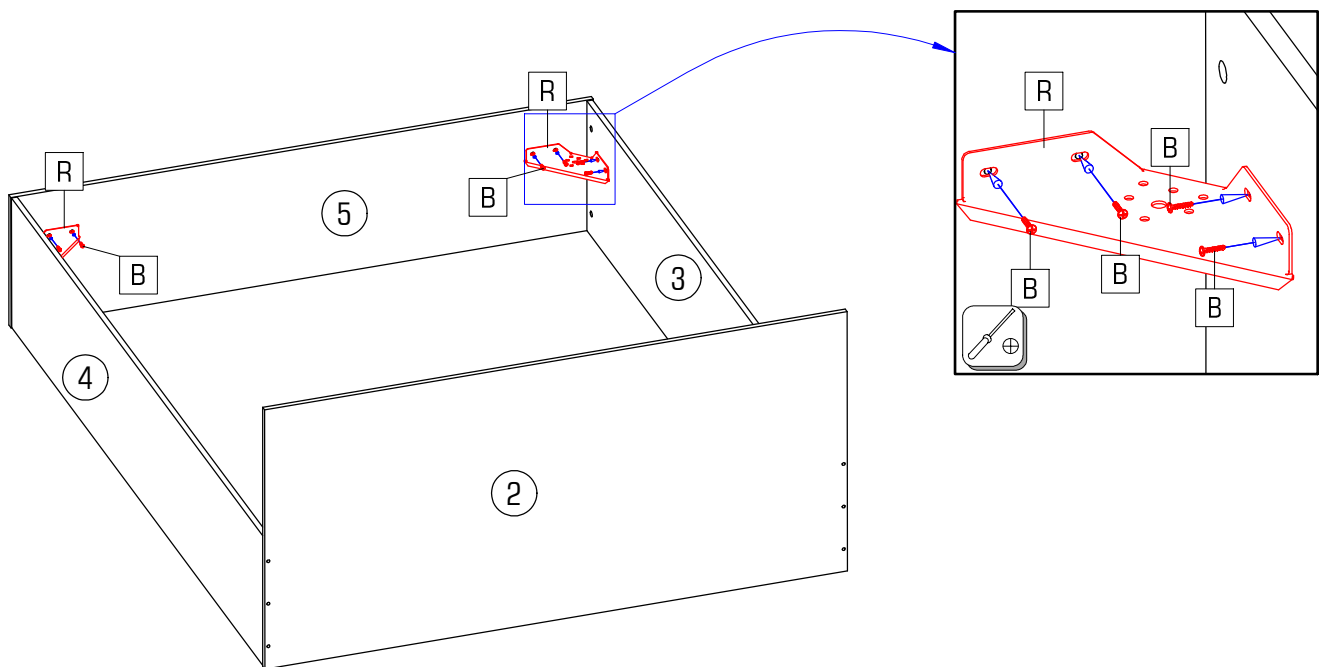
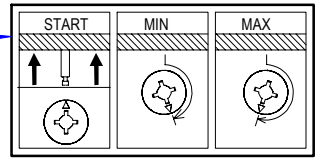
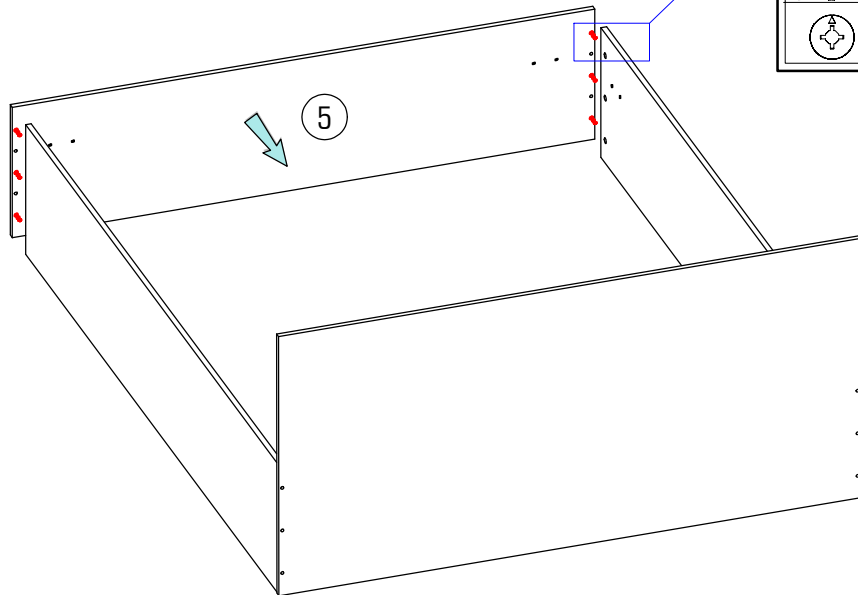
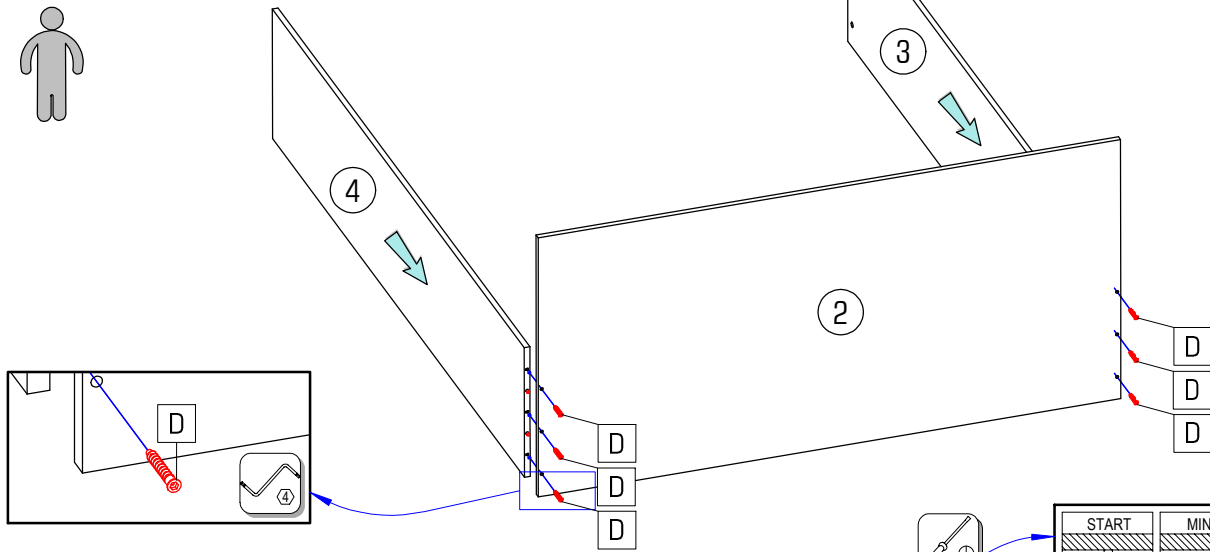
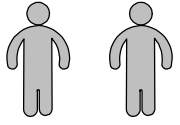
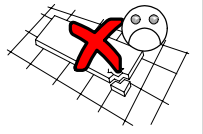
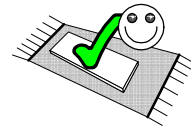

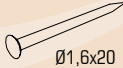

		
Ø5,0x16	Ø7x50	
B 8x	D 6x	R 2x

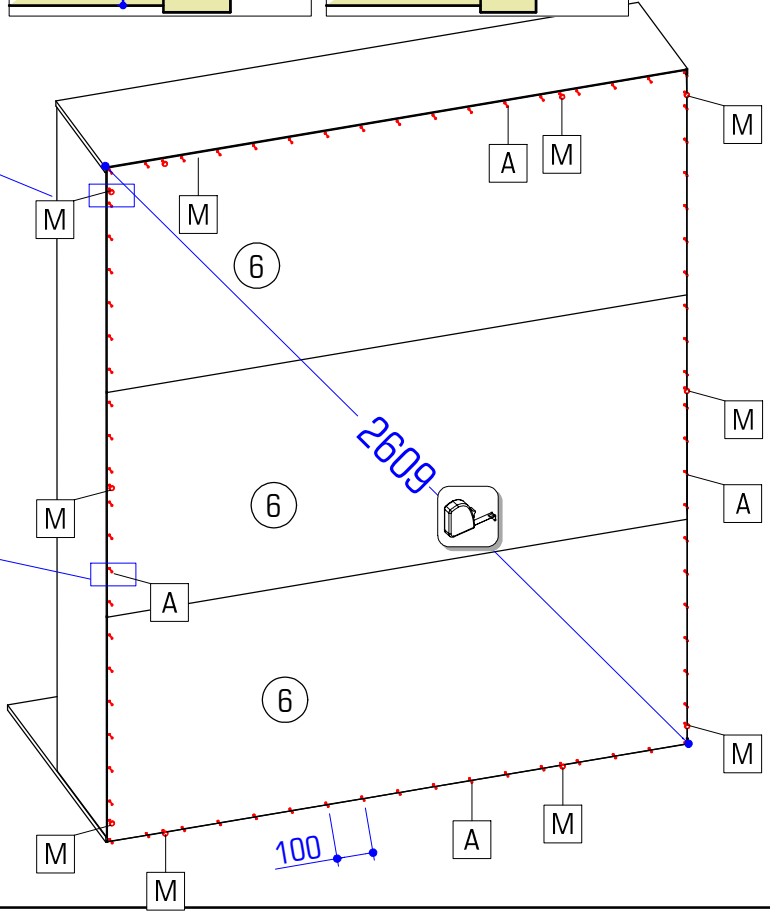
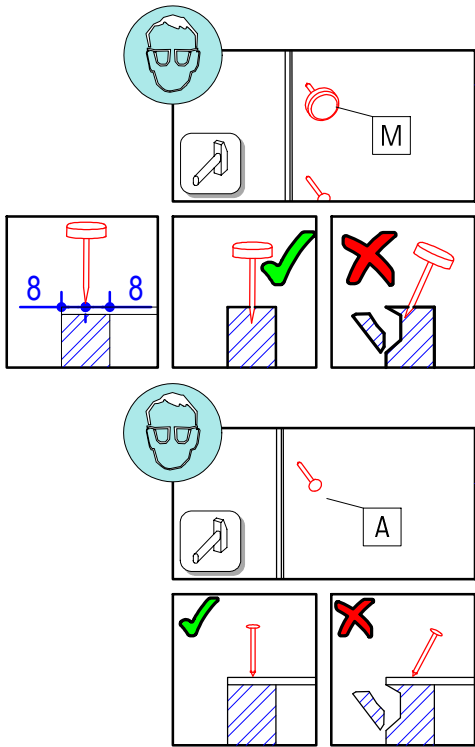
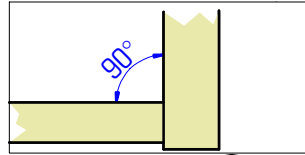
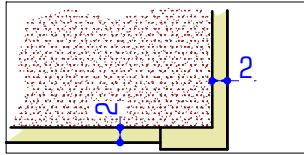
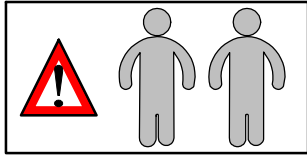

4/6 DOLI 160x200



	
A 100x	M 10x



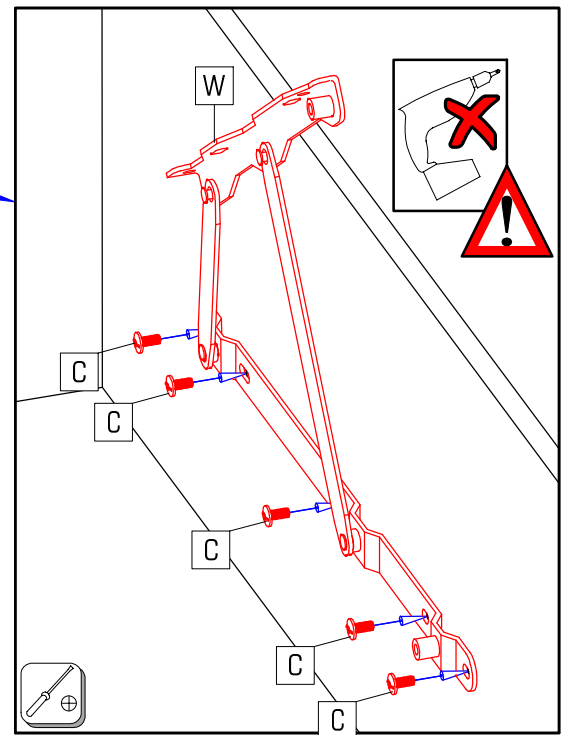
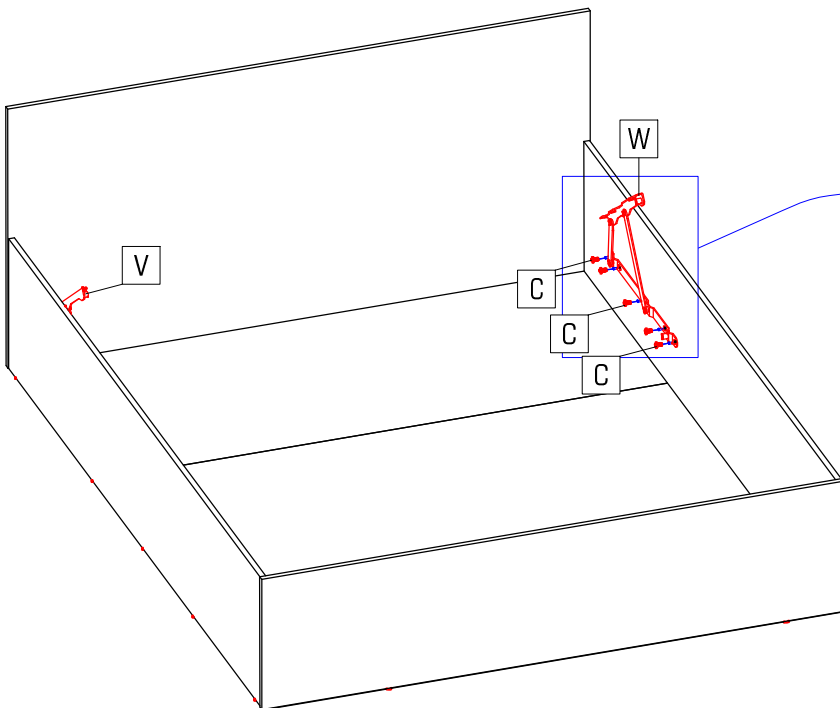
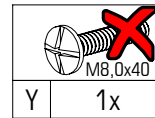
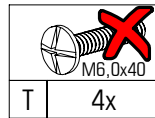
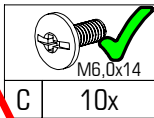



		
C 10x	V 1x	W 1x

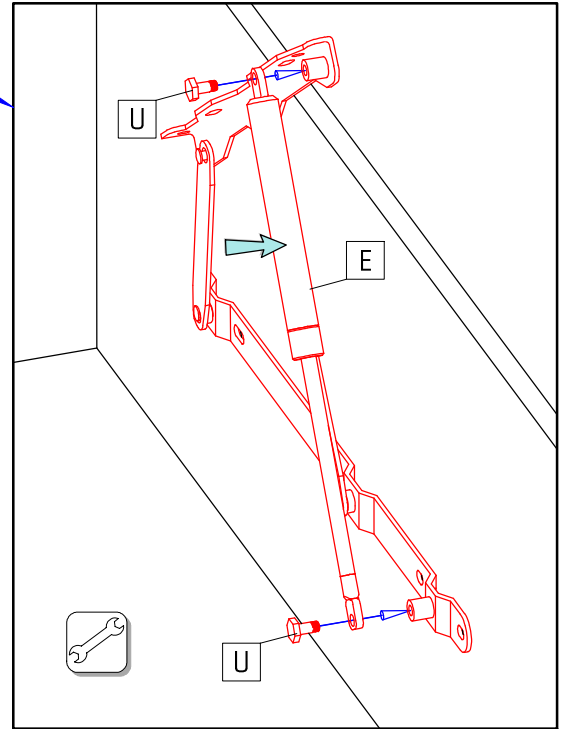
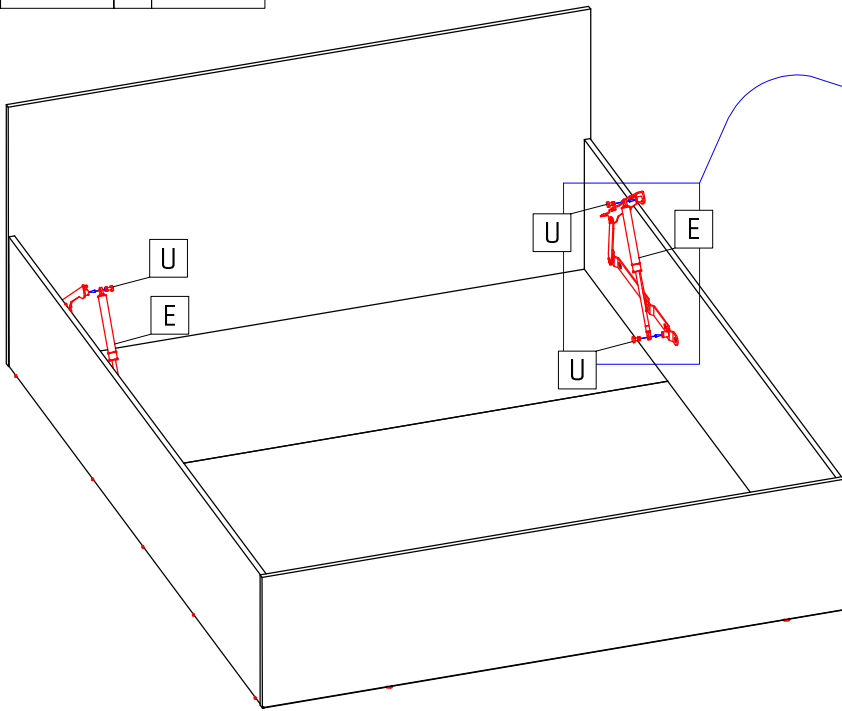

DOLI 160x200 5/6

	
1000 N	
E 2x	U 4x



			
F 2x	G 1x	H 1x	Y 1x
			M8,0x40





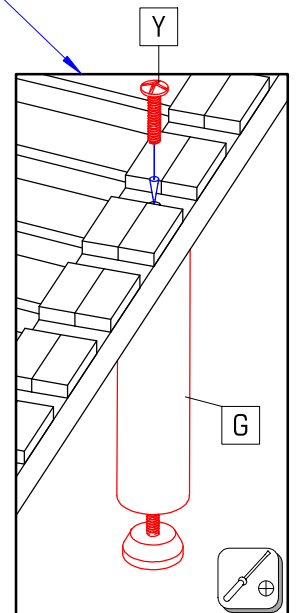
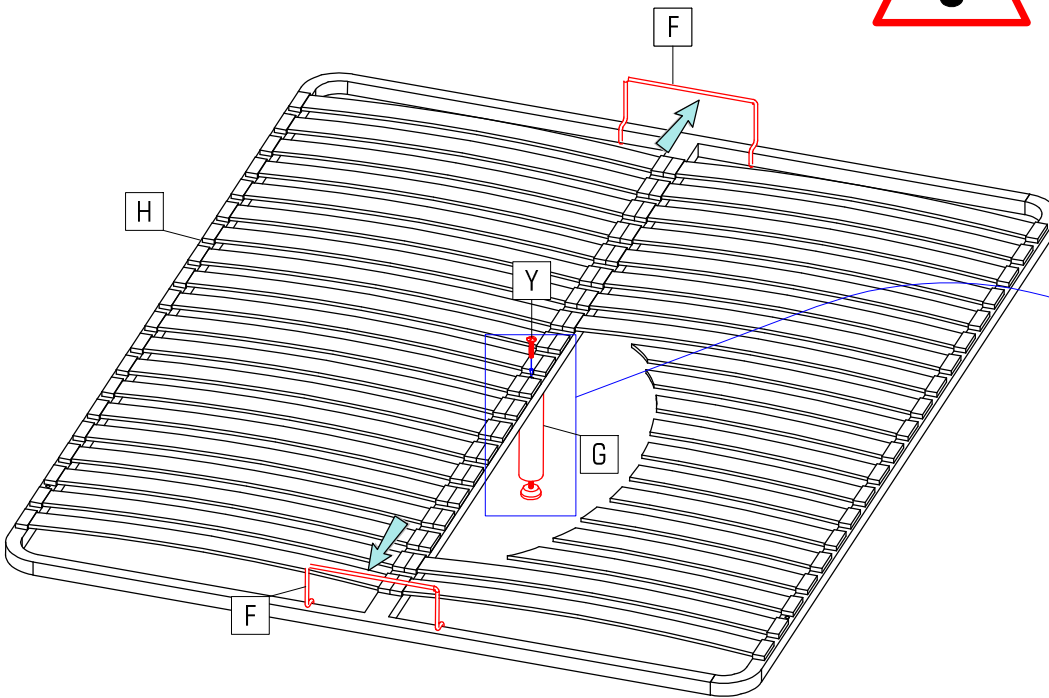

	
C 10x	M6,0x14

	
T 4x	M6,0x40

	
Y 1x	M8,0x40
	37153,00





6/6 DOLI 160x200

			
Q1	Q2	T	X
6x	6x	4x	4x



C
10x

T
4x

Y
1x

